







Technical data

Description:	Terminal block RKA 35
Construction:	Fingersafe IP 20
Item no. :	087210

Remarks:	The product is compliant with the EC ROHS directives
Standards:	IEC 60947-7-1 CE 
Nominal Voltage:	1.000 V AC / 1.000 V DC
Nominal current:	Cu 125 A
Rated cross-section:	35 mm ²
Impulse withstand voltage:	8 kV
Pollution degree:	3
Surge voltage category:	III
CTI value:	550
Terminal cross section:	

no. of connections: 2 x 35 mm ² (all conductor types)	IEC 60947-7-1	
	Cu	
35 mm ²		
25 mm ²	-	-
16 mm ²	6 Nm	6 Nm
10 mm ²		
6 mm ²		
4 mm ²	-	-
2,5 mm ²	-	-
stripping length	13 mm	
allen screw	M8 (SW 4 mm)	

 solid  compact stranded  fine stranded with ferrule

Materials:	Terminal body: Aluminium	tin plated
	Housing: PA 6 (Halogen-free)	
	Screws: Steel	zinc plated
Flame resistance:	Self-extinguishing	
Mechanical data:	Dimensions: width x height x depth (mm):	17,2 x 45,5 x 49,6

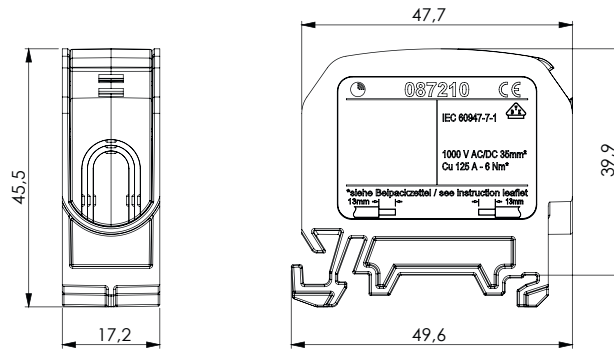

Design

Basic housing colour – light grey RAL 7035

Part no.	Design	Cover colour	PU	GTIN (EAN)
087210-0-3	L G	light grey RAL 7035	8 / 144	4051589010290
087210-1-3	N	light blue RAL 5012	8 / 144	4051589010306
087210-2-3	PE	yellow-green RAL 6018	8 / 144	4051589010313
087210-3-3	LB	clay brown RAL 8003	8 / 144	4051589010320
087210-4-3	L S	jet black RAL 9005	8 / 144	4051589010337